



02/2015 S200GB151S00

Our policy of constant technological upgrading means that technical specifications may be subject to change without prior notice.



S200 | Reliability is a building block for evolution

Sede Legale ed Amministrativa / Headquarters
CEFLA s.c.
Via Selice Prov.le, 23/a
40026 Imola (BO) - Italy
Tel. +39 0542 653111
Fax +39 0542 653344



Produttore / Manufacturer
Cefla Dental Group
Via Bicocca, 14/C - 40026 Imola (BO) - Italy
Tel. +39 0542 653441 - Fax +39 0542 653601
www.sternweber.com
sternweber@sternweber.com



INNOVATION IS POWER



**HEALTH FACILITY
MANAGER**

"Stern Weber just keeps on getting better. That's why it's the leading brand in the Dentistry Department".



ENDODONTICS SPECIALIST

"First-rate materials, user-friendly controls, all-round hygiene safeguards. Stern Weber gives me everything. Workplace safety at all times."



IMPLANTOLOGIST

"Cutting-edge instruments, perfect control and precise settings plus a patient chair that really makes the difference. For my specialisation, Stern Weber is the very best."

Evolution aims at perfection, finest details and rigorous constant improvement. Stern Weber's DNA is based on the wonders of technology, on enthusiasm for innovation, on the strength of genuine novelty. Rigour and precision are the key aspects of each new product, and the shapes of new design infuse such products with life. We believe in flexible working, in the perfection of true talent, in the importance of concrete steps being made towards true progress. We foresee the future today to guarantee a more innovative tomorrow.



OPPORTUNITY ZONE

Built on the concept of permanent reliability, the evolution of Stern Weber integrated treatment centres has resulted in ever-better advantages in terms of performance, ergonomics and practicality. This capacity to adapt and evolve is the key strength of the S200. Whatever your needs, the first thing you require is a dental unit designed for intensive use. The scope for personalisation goes well beyond the usual standards and provides all the very latest innovations developed by Stern Weber.

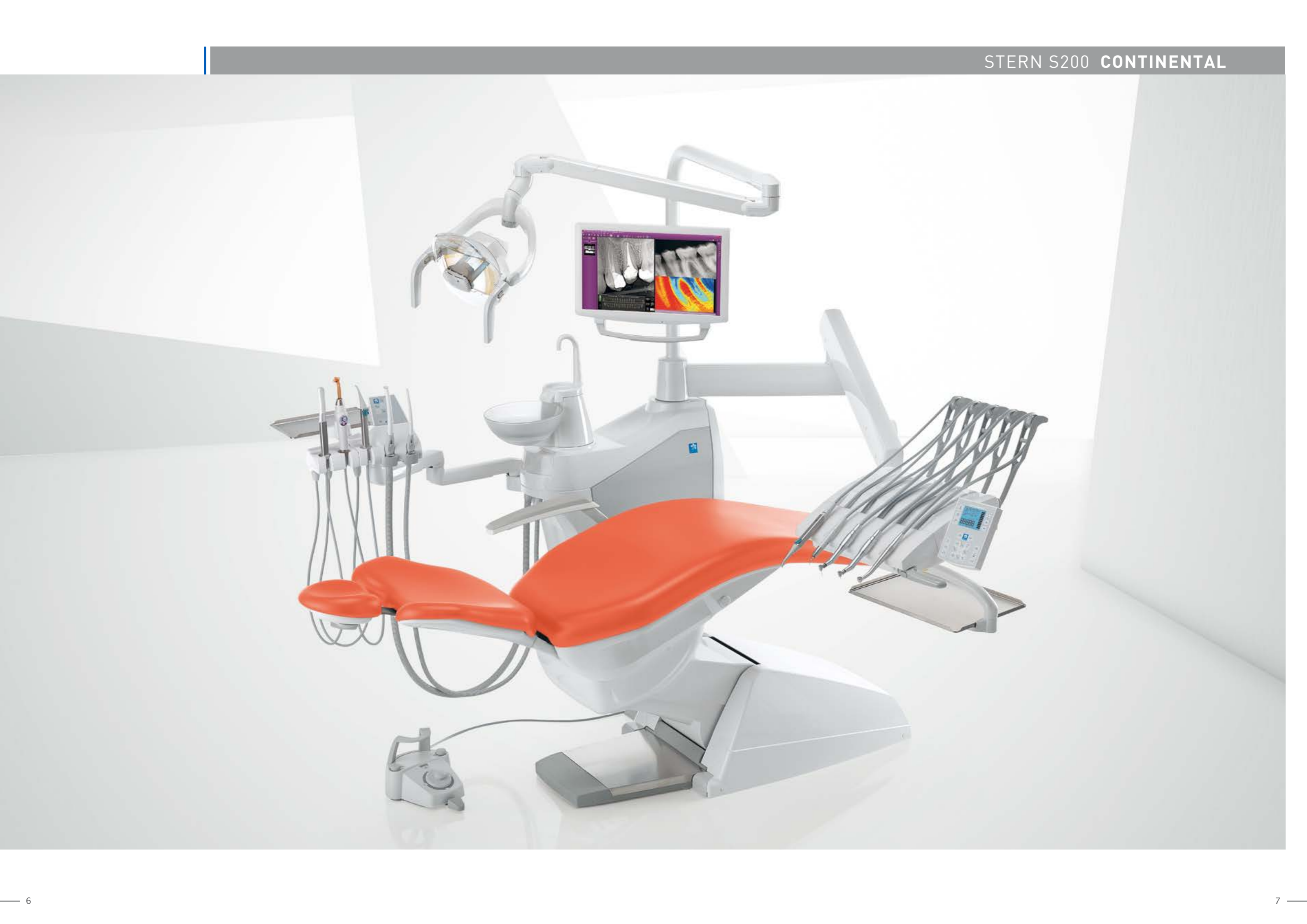





Arm options
The assistant's module can be fixed via a simple single arm, a double-jointed arm or the vertically adjustable arm.



Optional extension
The assistant's module can be fitted with an optional extension providing housing for camera and curing light.



Pneumatic lock
As an alternative to the standard mechanical lock on the instrument module arm, an optional pneumatic device can be fitted with conveniently located, push-button activation.



Rotating cuspidor bowl
The cuspidor unit rotates up to 270° and can be fitted with an optional motor-driven function. The velvet-finish tempered glass cuspidor bowl is also available in ceramic.



Armrests
Both patient chair armrests are made of painted die cast aluminium with surfaces in soft-touch material; they can easily be rotated forwards to facilitate patient access.

Built to work for you

Designed to fit into your routine, each aspect of the treatment centre is conceived to help improve workflow and significantly reduce physical fatigue connected with incorrect posture, both for dentist and assistant staff. Patient chair shaping enables easy access to the operating zone and the excellent scope of the instrument module, mounted either on the standard arm or a shorter 500 mm version, allows for outstanding versatility whether you are assisted or working alone. Further features include simple foot-controlled deactivation and reactivation of the suction cannulae, instrument tubing with quick-couplings and a choice of three types of module arms on the assistant's side.

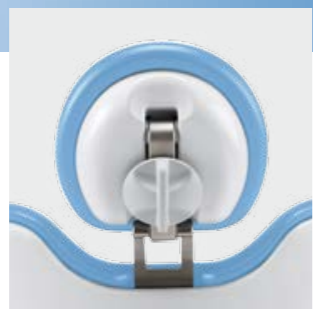

Atlaxis - Universal

As an alternative to the standard Universal headrest, the pneumatic Atlaxis headrest can be positioned using just one hand. Without mechanical levers or brakes, the push-button release allows for fast, precise adjustments which respect the anatomy of the neck joints. Vertical extension is enabled via the support rod.

Memory Foam

Optional Memory Foam padding ensures greater patient comfort and relaxation. Available in 8 colours.

Treat your patients to exceptional comfort

Stern Weber dedicates the utmost attention to the comfort factor. When a patient feels at ease your job is much simpler, workflow becomes more efficient and a patient's assessment of treatment outcome is likely to improve.

In addition to the design features which create comfortable working conditions for you and your staff, S200 can be equipped with premium quality accessories to enhance the patient experience in every possible way.

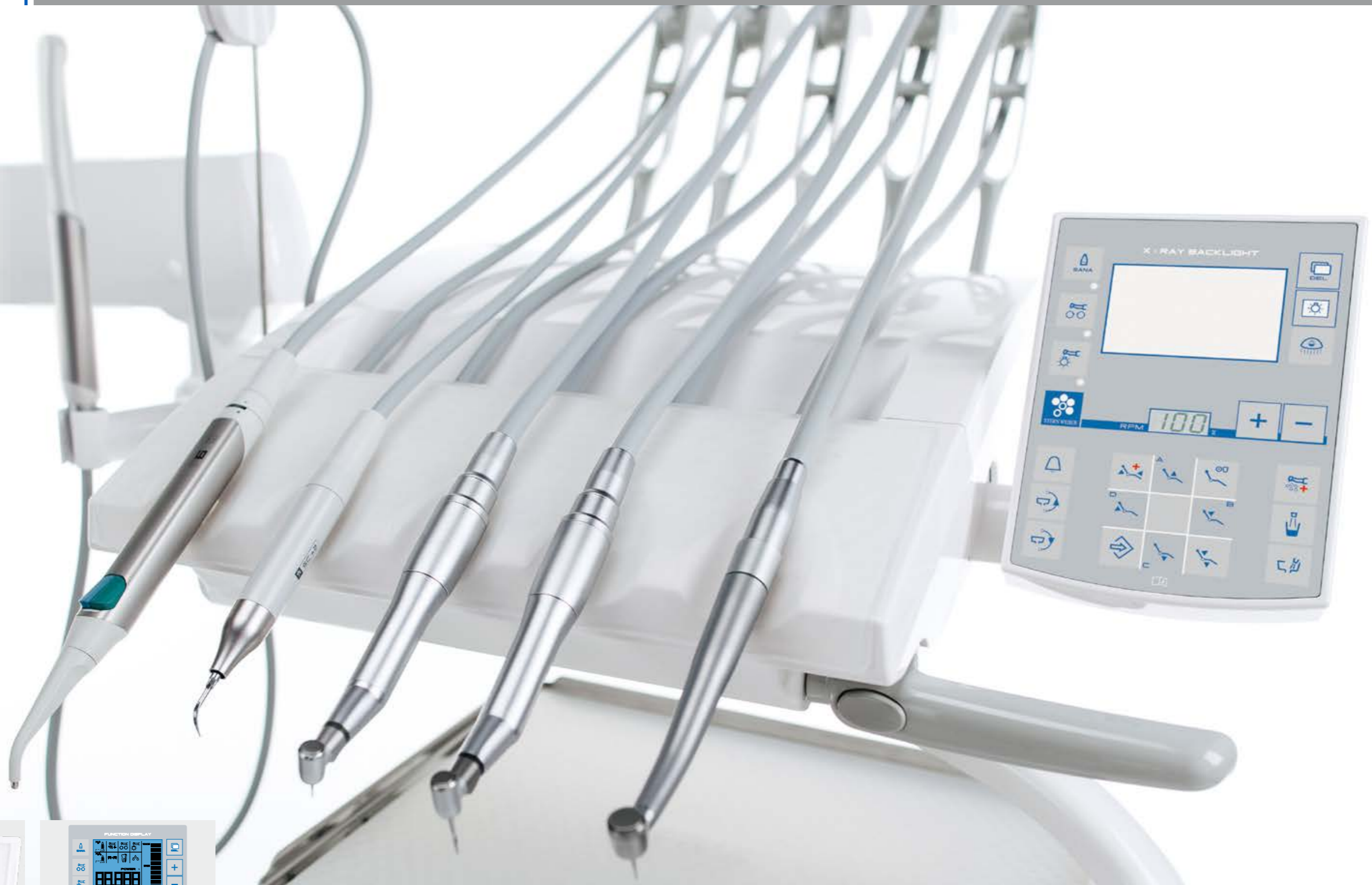

X-ray viewer
The ergonomically designed International module integrates both types of control panel and can be fitted with an optional panoramic X-ray viewer.

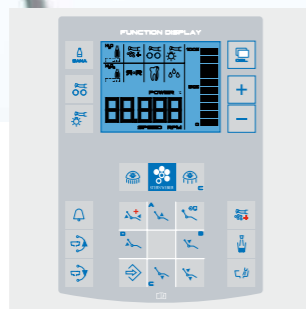

LCD control panel
The LCD control panel enables precision adjustments of the brushless micromotor, visualisation of spray status, independent supply bottle level and LED lighting intensity selection, and allows for the integration of Stern Weber's BIOSTER S disinfection device.

Effective control leads to effective treatment

Creating the ideal conditions for efficiency is the guiding principle for the range of control units available on Stern Weber treatment centres. As standard configuration, S200 is equipped with a highly intuitive 3-digit display panel which allows for instrument speed and power adjustments. This unit also incorporates a rear-lit X-ray viewer.

The optional LCD control panel, with easy-to-read icons, provides comprehensive data regarding instrument parameters and dental unit operating status, as well as additional keys for semi-automatic hygiene devices and all the customary keys for patient chair movements, lighting and other functions.



- Venus Plus - L LED**
- Light intensity from 3,000 to 50,000 Lux
 - Adjustment via potentiometer or no-touch sensor
 - Colour temperature: 5,000 K
 - 3-axis rotation
 - Low-thermal emission LED light sources
 - LEDs guaranteed to work 50,000 hours



- Venus Plus**
- Light intensity from 8,000 to 35,000 Lux
 - Potentiometer and soft-start device
 - Colour temperature: 4,900 K
 - 3-axis rotation



- Venus (standard feature)**
- Light intensity: 8,000 / 22,500 Lux
 - Colour temperature: 4,900 K
 - 2-axis rotation

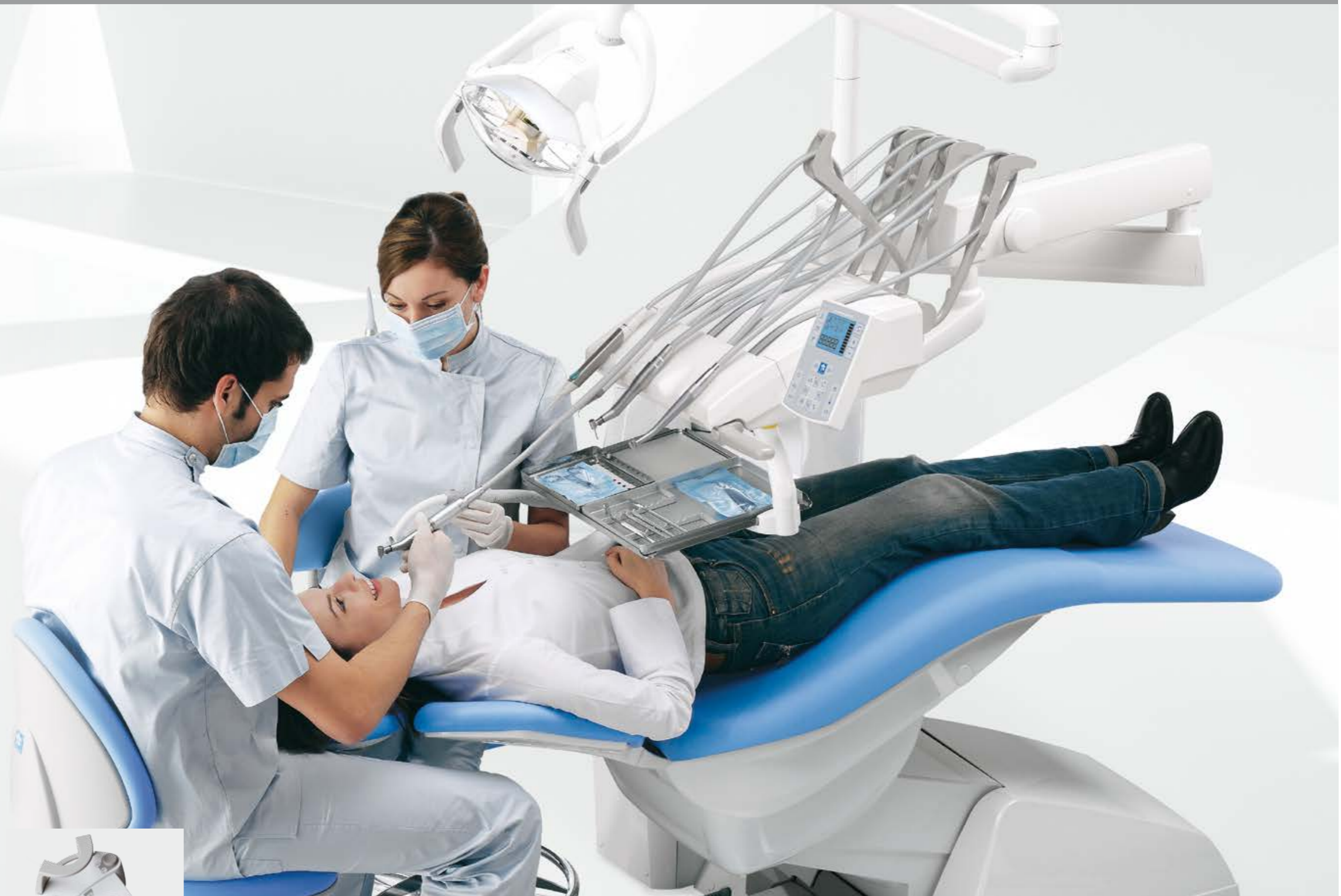

Power Pedal Foot Control



Pressure-operated Foot Control



Multi-function Foot Control

Foot controls can be used to operate patient chair movement, activate Chip Air and Chip Water on the instrument in use and also activate the extracted instrument (with and without spray).

Make the most of multiple options

What adds extraordinary value to the S200 unit is the wide-ranging availability of high-tech accessories which you can select to customise your ideal treatment centre. Over and above the ergonomic set-up, fourteen upholstery colourings, the choice of up to five additional hygiene systems, two control panels and Stern Weber instruments, you can opt for one of three different operating lights and five foot control units.

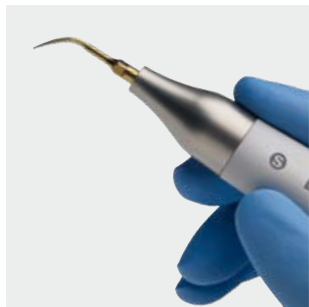
**SC Scalers**

Indicated for supragingival prophylaxis tasks of the periodontal type and for the preparation of small cavities and in endodontic root canal cleaning techniques. Power levels are shown on the display.

**i-XR3 / i-XR3L**

Brushless micromotor with minimal maintenance requirements, cold-disinfectable, suitable for conservative and prosthetic dentistry. Optional LED lighting available with the 3L version.

- Torque up to 3.3 Ncm
- Speed range from 100 to 40,000 rpm
- Dimensions: Ø22 x 34 mm
- Weight: 67 g

**Sixth instrument**

On both versions (Continental and International), the dentist's module can be fitted with an optional sixth instrument: camera or curing light.

**Quick couplings**

Tubing on both dentist's and assistant's modules can easily be replaced via the quick couplings.

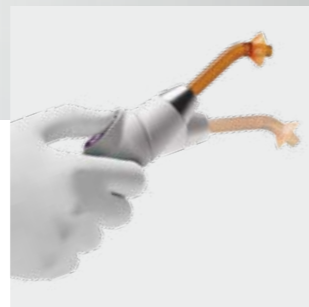
**T-LED**

Exclusive patented curing light with ergonomic 180° swivel-grip and 6 programmes for polymerisation and bonding tasks. Depending on the programme, delivered energy ranges from 11,250 mJ to 36,000 mJ.

**Benefit from the best levels of performance**

An array of advanced instruments designed by Stern Weber, fully integrated with the treatment centre's electronics and control units, is an option which can deliver the performance you need to confidently handle all aspects of conservative and prosthetic dentistry.

Whichever configuration you choose for the dentist's module, you are sure to benefit immediately from user-friendly controls, top performance levels and an ergonomic design for each handpiece.



RXDC HyperSphere+
DC X-ray unit with integrated 30 cm collimation, designed for digital radiology. Provides pin-sharp images thanks to a focal spot of just 0.4 mm.



Ball joint
A spherical ball-joint and a lock/release mechanism activated by 2 touch-sensitive areas on the tube head ensure that positioning is both fast and precise.



Wireless handheld unit
The handheld wireless control device features 4 keys to adjust exposure and another key to take the X-ray. The RXDC automatically calculates the correct exposure on the basis of the selected anatomic area.



Zen-X
X-ray sensor integrated on the dentist's module. Well-built, ergonomic and available in two sizes, contains a CMOS sensor for high resolution images.



Integration completes your professionalism

The major advantage of unit-integrated radio-diagnostics is speed and productivity. Immediate answers make treatment sessions efficient and conclusive. Cutting-edge equipment and the unrivalled user-friendliness simply transform S200 into a high-tech, high-performance treatment centre.

Consisting of an X-ray unit with wireless control, digital sensor and medical-grade LED monitor, the onboard system eliminates all the inconveniences associated with separate equipment installation.

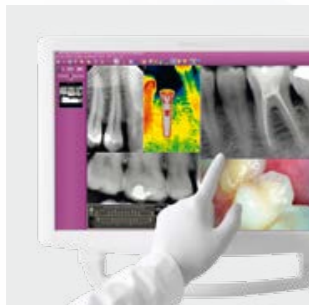

19" LED Monitor
CE 93/42 certified, the 16:9 monitor comes complete with a lead for connection to the PC. LED light sources ensure outstanding contrast and brightness. A touch-screen version is also available.



Double-jointed arms
For the touch-screen version the optional double-articulated arm is recommended to move the screen in closer or further away from the operating zone. The screen is also tilt-adjustable.

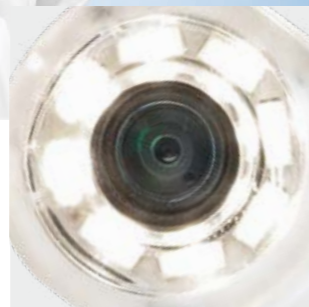
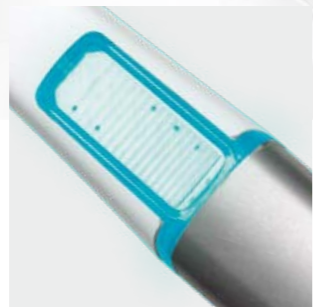
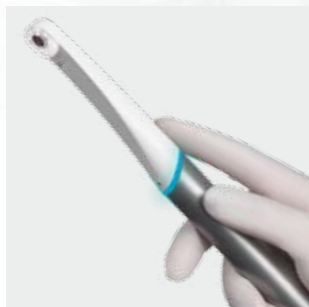

C-U2 HD camera
A digital camera with HD sensor and glass optics, the C-U2 provides high-resolution images in full-screen format on the LED monitor. The optical system with 7 glass lenses and a F/8 aperture guarantees excellent brightness and an extensive depth of field (min. 5 mm max. 70 mm) with any need for manual focussing. The backlit multi-function button enables the operator to freeze frame images and to subsequently store them.



Your working relationship

Gaining trust is based around a person-to-person relationship and the Stern Weber multimedia system is the fastest way to explain treatment, illustrate results and reassure your patients. Once your patient communication is supported by practical multimedia technology, you will discover the advantages of each single integrated device: a new high performance camera with HD sensor in the 16:9 format and a 19" flat screen monitor with LED technology.

W.H.E. (Water Hygienisation Equipment)

A combination of a continuous disinfection system and a device that ensures an air gap between the mains water circuit and dental unit water circuits. The microbiological quality of the water inside the dental unit is guaranteed by utilisation of **Peroxy Ag+** (H₂O₂). At the concentration recommended by Stern Weber, this substance acts effectively against all species of water-borne contaminants such as bacteria, including Legionella, for which just 10 minutes of contact is sufficient.



Automatic Chip Air

This system, featured as standard, automatically emits an air jet when you stop using dynamic instruments so as to clean any residual liquids or solids from the handpiece.



SANASPRAY S

Distilled water can be used by bypassing the mains water. To carry out rapid circuit sanitisation a second tank is available. Given its tried and tested effectiveness, the use of **Peroxy Ag+**-disinfectant is recommended.

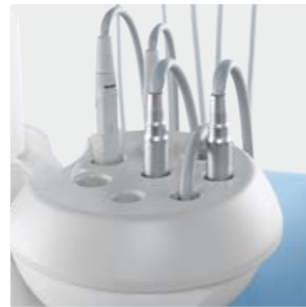

BIOSTER S

The semiautomatic system draws the disinfectant from the SANASPRAY tank and executes the intensive spray circuit disinfection cycles. The **I.W.F.C.** flushing system, also available separately, ensures tubing is kept clean after the machine has remained idle for a time. BIOSTER S is only available where the LCD control panel is present.



A.C.V.S.

Automatic system for suction system sanitisation cycles between patients. Extensive filtration surface area on the easily accessed double filters ensures maximum efficiency and reduces emptying frequency. Independent filter selection is an optional feature.



Disposable covers

Dentist's and assistant's module feature disposable covers.



Easy access

Regular maintenance is made easy thanks to easy access into the unit body.

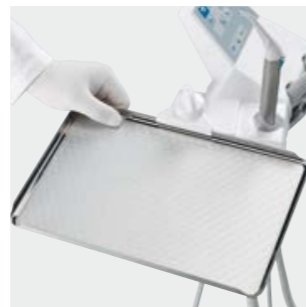

Tray holder

The rotating tray-holder is made of stainless steel and can be removed for sterilisation.



Cuspidor bowl

The rotating cuspidor bowl can be dismantled for sanitisation purposes.



Tank filling

Opening the unit body door gives immediate access for topping up the reservoir.



Padding

Patient chair padding is removable, as are many other elements.



Handpiece support

The instrument holder panel is removable and the soft, silicon instrument mat is both removable and autoclavable.



Cannula roller guides

Removable holder guides facilitate the extraction and replacement of the suction cannulae. Cannulae terminals are removable and autoclavable.

Raise the standards to your rank

When you opt for a Stern Weber treatment centre, you can personalise most aspects exactly as you wish. This is particularly true when selecting from a vast array of hygiene solutions which ensure you and your patients are protected in the best possible way. And it is even more true in the case of the S200 unit.

All components, large and small, are designed to minimise risks of contamination. Surface finishing, special plastics and autoclavable materials are part of an all-inclusive passive hygiene concept. Active devices and easy-to-use, scientifically proven sanitisation procedures can be chosen according to specific requirements. What you benefit from, above all, is Stern Weber's yearlong experience in the field.

Orrù et al. - Evaluation of Antimicrobial - Antibiofilm Activity of a Hydrogen Peroxide Decontaminating System used in Dental Unit Water Lines - The Open Dentistry Journal, 2010; 4: 140-146

Orrù et al. - Valutazione dell'attività antimicrobica di un sistema decontaminante a base di perossido d'idrogeno. Risultati in vitro e su riunito odontoiatrico - Il Dentista Moderno 2006; dicembre: 60-71

S200	INTERNATIONAL	CONTINENTAL
------	---------------	-------------

HYGIENE SYSTEMS

BIOSTER S - available only when the dentist's module is fitted with the LCD control panel	*	*
A.C.V.S.	*	*
SANASPRAY S	*	*
W.H.E.	*	*
I.W.F.C.	*	*

DENTIST'S MODULE

Control panel with 3 DIGIT display	●	●
Control panel with LCD display	*	*
Micromotor i-XR3 (100 – 40,000 rpm)	●	●
Micromotor i-XR3L with f.o. (100 – 40,000 rpm)	*	*
Midwest module with f.o.	●	●
SC Scalers (with or without f.o.)	*	*
6-way syringe	*	*
Sixth instrument	*	*
X-ray viewer for panoramic X-rays	*	-
Integrated X-ray sensor	*	*

UNIT BODY

Glass cuspidor bowl	●	●
Ceramic cuspidor bowl	*	*
Cuspidor bowl drive	*	*
Cup water heater	*	*
Spray heating	*	*
Independent cannulae selection	*	*
Suction stop device on chair base	●	●
Multimedia applications wiring	*	*
Assistant's tray-holder	*	*
Venus Plus-L LED operating light	*	*
Venus Plus operating light	*	*
Venus operating light	●	●

PATIENT CHAIR

Atlaxis headrest	*	*
Mobile, removable right armrest	*	*
Left armrest	●	●
Child's cushion	*	*
Multi-function foot control	●	●
Pressure-operated foot control	*	*
Power Pedal foot control	*	*
Multi-function (wireless) foot control	*	*
Pressure-operated foot control (wireless)	*	*
Full seat cover for patient chair	*	*

● as standard * optional - unavailable

CONTINENTAL

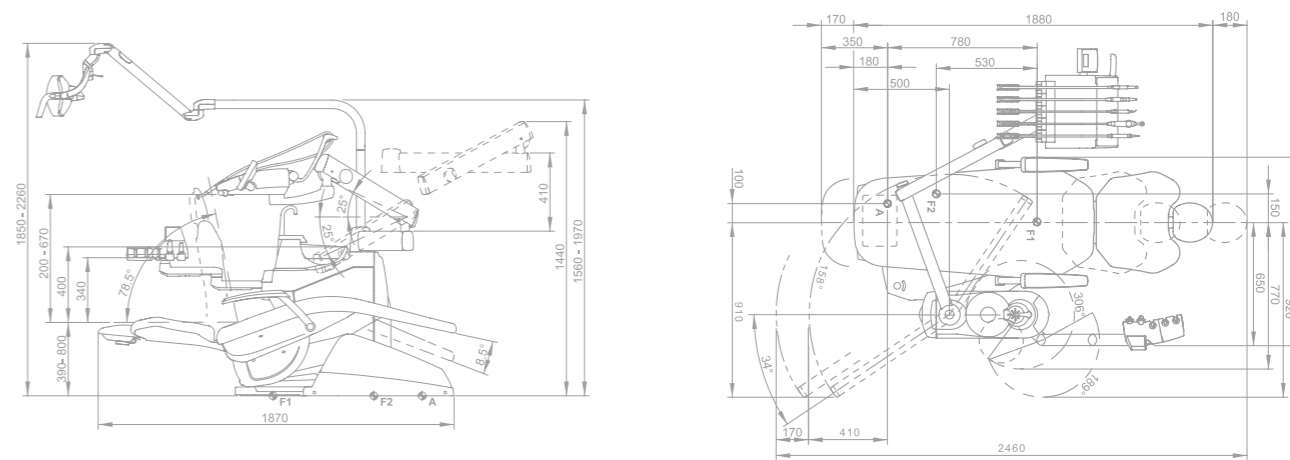

INTERNATIONAL

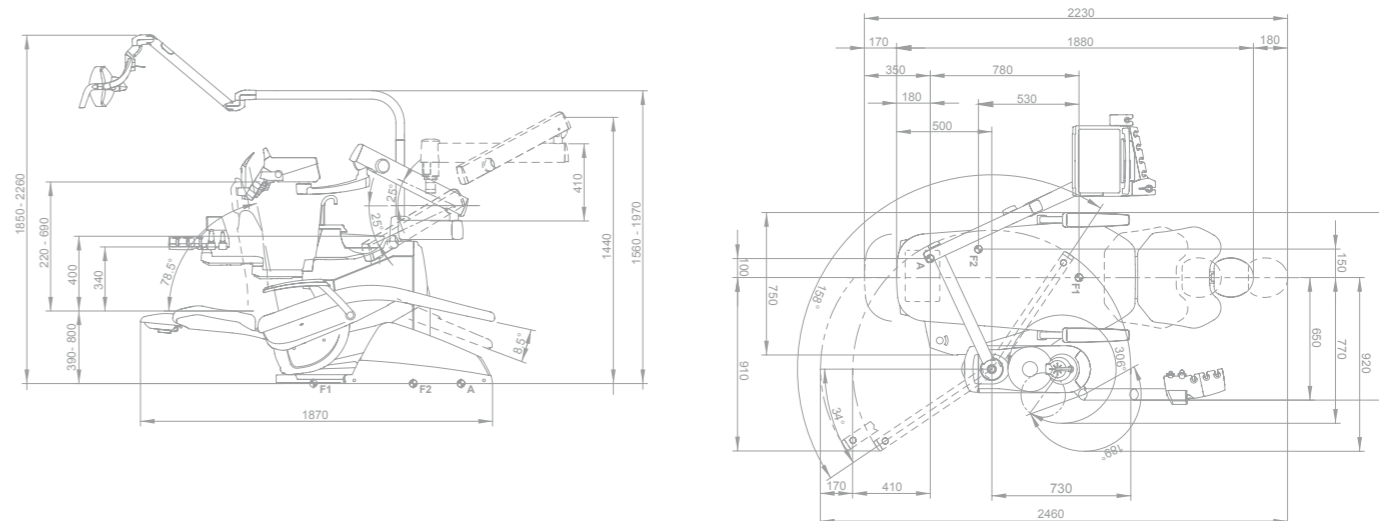

Dimensions are quoted in millimetres.

